











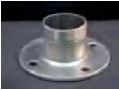



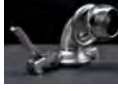



















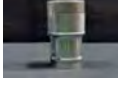







ENLACES DE ROTULA

en acero zincado o en inox

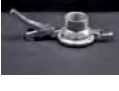

- Fabricados en chapa con tratamiento de Zincado o en acero INOX.
- Indicados para cualquier instalación de transporte de agua y líquidos con una presión no superior a 8 BAR.
- Podemos fabricar rápidamente cualquier medida y combinación que precise el cliente, aunque no esté indicado en este catálogo.

ÍNDICE ENLACES

FIGURA	Pag.	FIGURA	Pag.	FIGURA	Pag.			
	Fig. 10 Brida para soldar	21		Fig. 24 Hembra Rosca codo 90°	15		Fig. 42 Tapón Macho	13
	Fig. 11 Hembra para soldar	7		Fig. 25 Macho Rosca	9		Fig. 43 Macho - Hembra codo 90°	17
	Fig. 12 Brida Rosca Interior	21		Fig. 25 R.I. Macho Rosca Interior	9		Fig. 44 Brida Macho codo 90°	23
	Fig. 13 Junta	8		Fig. 26 Macho Manguera codo 90°	16		Fig. 45 Macho Brida PN-10	19
	Fig. 14 Junta Brida PN-10 PN-16	23		Fig. 27 Macho Manguera	12		Fig. 46 Curva 90° Norma 3	31
	Fig. 15 Macho para soldar	7		Fig. 28 Brida Manguera codo 90°	22		Fig. 47 Rosca - Manguera	27
	Fig. 16 Tubo Manguera Regatas	26		Fig. 29 Tubo Roscado	24		Fig. 48 Manguera-Mang. Bordón	28
	Fig. 17 Hembra Manguera codo 90°	14		Fig. 30 Cono concéntrico	31		Fig. 49 Rosca - Rosca	27
	Fig. 18 Manguera-Mang. Regatas	29		Fig. 32 Reducción Rosca-Mang.	30		Fig. 50 Brida PN-10 para soldar	18
	Fig. 19 Reducción Manguera-Mang.	29		Fig. 34 Macho Rosca codo 90°	15		Fig. 70 Reducción Rosca-Rosca	30
	Fig. 20 R.I. Tubo Roscado Interior	25		Fig. 36 Macho - Macho codo 90°	18		Fig. 90 Esparcidor Hembra Fig.	32
	Fig. 21 Hembra Manguera	11		Fig. 38 Tubo Manguera Bordón	25		Fig. 91 Esparcidor codo Hembra	33
	Fig. 22 Hembra Rosca	10		Fig. 39 Manguera - Mang. codo 90°	17		Fig. 92 Esparcidor codo Macho	33
	Fig. 22 R.I. Hembra Rosca Interior	10		Fig. 40 Brida Manguera	20		Fig. 93 Esparcidor Macho	32
	Fig. 23 Aro	8		Fig. 41 Tapón Hembra	13			

MEDIDAS EN ACERO ZINCADO

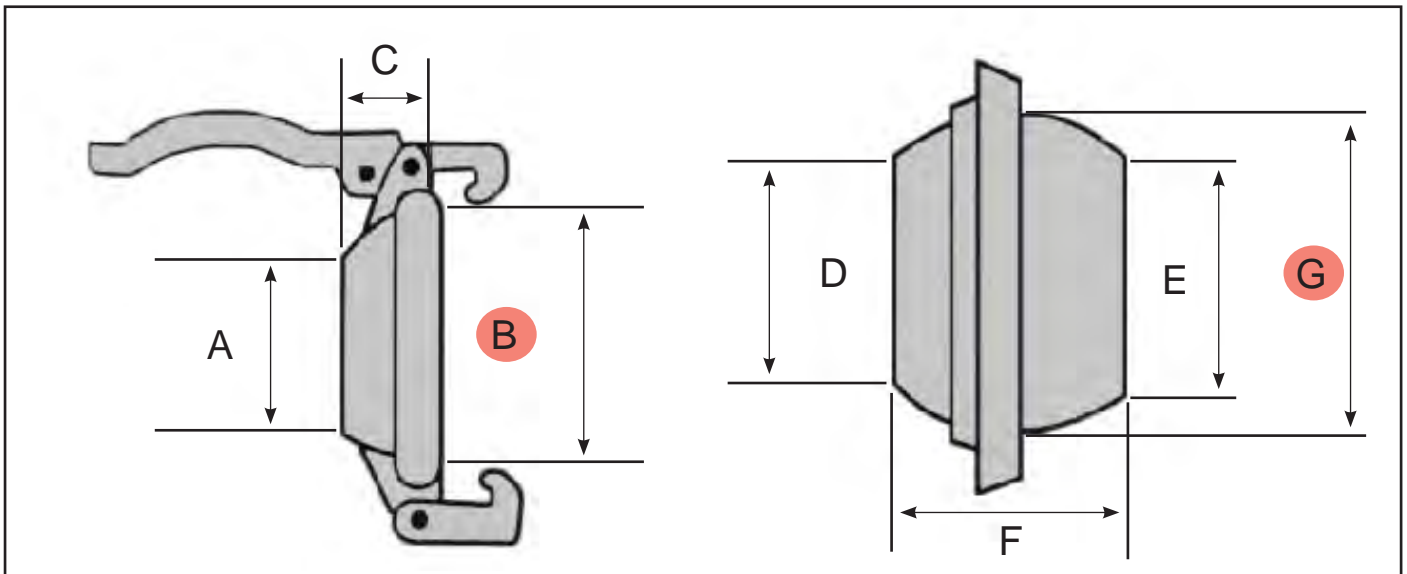

HEMBRA

MACHO

ENLACE BASE		50	60	80	100	115	140	200	250
HEMBRA	A	43	53	72	92	107	136	185	236
	B	70	90	114	131	152	180	243	300
	C	38	48	53	55	63	80	97	118

MACHO	D	43	51	72	92	110	139	185	235
	E	51	63	83	100	120	150	203	252
	F	53	68	83	94	97	104	140	170
	G	70	90	110	130	150	180	242	300

B y G = MEDIDAS MÁS IMPORTANTES PARA IDENTIFICAR LOS ENLACE BASE

MEDIDAS EN ACERO INOXIDABLE

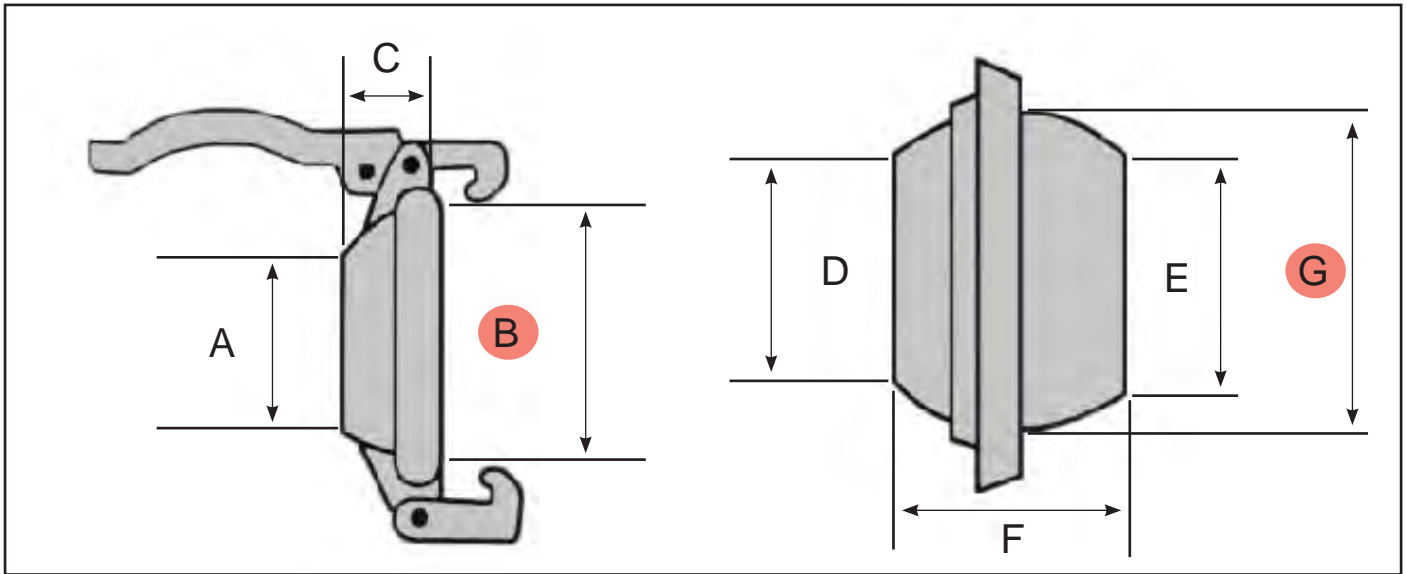

HEMBRA

MACHO

ENLACE BASE	
MEDIDA	
HEMBRA	A
	B
	C

50					80			100		115	140
35	40	45	50	60	75	80	90	100	110	125	150
37	42	47	52	61	77	82	87	104	110	125	150
72					111			134		153	183
33					52			58		62	62

ENLACE BASE	
MEDIDA	
MACHO	D
	E
	F
	G

50				80		100		115	140
1"	1 1/4"	1 1/2"	2"	2 1/2"	3"	3 1/2"	4"	4 1/2"	5" - 6"
34	43	49	61	75	84	109	114	124-129	155
51				83		104		124	154
53				83		88		94	96
70				110		130		150	180

B y G = MEDIDAS MÁS IMPORTANTES PARA IDENTIFICAR LOS ENLACE BASE



FIG. 15

MACHO PARA SOLDAR CON ARO

ENLACE BASE	ROSCA	Ø MANGUERA
50	1" - 1 1/4" - 1 1/2"	30 - 35 - 40 - 45 - 50
	2"	60
60	2"	60
80	2 1/2" - 3"	70 - 75 - 80 - 90
100	3 1/2"	100
	4"	110
115	4"	110 - 115 - 125
	4 1/2"	125
140	5" - 6"	140 - 150
200		200
250		250

ACERO ZINCADO	
Cod.	P.V.P.
1000.021	2,46 €
1000.838	3,70 €
1000.022	3,50 €
1000.023	5,03 €
1000.024	6,69 €
-	-
1000.025	8,64 €
-	-
1000.026	12,13 €
1000.027	28,48 €
1000.028	-

INOX 304	
Cod.	P.V.P.
1900.014	13,19 €
1900.015	13,19 €
-	-
1900.016	25,30 €
1900.018	31,77 €
1900.019	31,77 €
-	-
1900.020	40,21 €
1900.022	54,10 €
-	-
-	-



FIG. 11

HEMBRA PARA SOLDAR CON JUNTA

ENLACE BASE	ROSCA	Ø MANGUERA
50	1" - 1 1/4" - 1 1/2"	30 - 35 - 40 - 45 - 50
	2"	60
60	2"	60
80	2 1/2" - 3"	70 - 75 - 80 - 90
100	3 1/2"	100
	4"	110
115	4"	110 - 115 - 125
	4 1/2"	125
140	5" - 6"	140 - 150
200		200
250		250

ACERO ZINCADO	
Cod.	P.V.P.
1000.001	6,12 €
1000.839	6,82 €
1000.002	6,84 €
1000.003	8,51 €
1000.004	9,48 €
-	-
1000.005	11,70 €
-	-
1000.006	15,57 €
1000.007	42,10 €
1000.008	57,08 €

INOX 304	
Cod.	P.V.P.
1900.001	21,00 €
1900.002	21,00 €
-	-
1900.004	38,80 €
1900.006	46,19 €
1900.007	46,19 €
-	-
1900.008	51,48 €
1900.010	66,64 €
-	-
-	-



FIG. 13

JUNTA

ENLACE BASE	MEDIDAS		
	GROSOR	Ø INT.	Ø EXT.
50	9	62	80
60	10	84	104
80	12	101	125
100	13	118	144
115	14	140	168
140	16	170	202
200	18	237	273
250	22	276	320

ACERO ZINCADO	
Cod.	P.V.P.
1000.011	0,84 €
1000.012	0,93 €
1000.013	1,16 €
1000.014	1,46 €
1000.015	2,58 €
1000.016	3,65 €
1000.017	8,49 €
1000.018	18,37 €

INOX 304	
Cod.	P.V.P.
1900.040	1,62 €
-	-
1900.042	3,07 €
1900.044	3,95 €
1900.046	4,30 €
1900.048	5,13 €
-	-
-	-



FIG. 23

ARO

ENLACE BASE
50
60
80
100
115
140
200

ACERO ZINCADO	
Cod.	P.V.P.
1000.081	0,91 €
1000.082	1,36 €
1000.083	2,58 €
1000.084	3,57 €
1000.085	4,88 €
1000.086	6,92 €
1000.087	16,57 €

INOX 304	
Cod.	P.V.P.
1900.140	7,05 €
-	-
1900.142	10,44 €
1900.144	15,15 €
1900.146	19,32 €
1900.148	21,58 €
-	-

FIG. 25
MACHO ROSCA

ENLACE BASE	ROSCA
50	1"
	1 1/4"
	1" 1/2
	2"
60	2"
80	2 1/2"
	3"
100	3 1/2"
	4"
115	4"
	4 1/2"
140	5"
	6"

ACERO ZINCADO	
Cod.	P.V.P.
1000.091	8,49 €
1000.092	7,13 €
1000.093	7,48 €
1000.847	9,16 €
1000.094	9,25 €
1000.095	14,18 €
1000.096	15,84 €
1000.097	19,72 €
-	-
1000.098	25,62 €
-	-
1000.099	35,92 €
1000.100	40,06 €

INOX 304	
Cod.	P.V.P.
1900.154	24,72 €
1900.156	27,77 €
1900.158	29,88 €
1900.160	30,71 €
-	-
1900.162	42,83 €
1900.164	44,22 €
-	-
1900.166	55,54 €
-	-
1900.168	67,64 €
1900.170	82,72 €
1900.172	87,00 €

FIG. 25 R.I.
MACHO ROSCA INTERIOR

ENLACE BASE	ROSCA
50	1"
	1 1/4"
	1" 1/2
	2"
60	2"
80	2 1/2"
	3"
100	3 1/2"
	4"
115	4"
	4 1/2"
140	5"
	6"

ACERO ZINCADO	
Cod.	P.V.P.
1000.111	7,12 €
1000.112	7,30 €
1000.113	7,48 €
1000.849	10,28 €
1000.114	10,11 €
1000.115	13,72 €
1000.116	15,63 €
1000.117	-
-	-
1000.118	24,90 €
-	-
1000.119	39,24 €
1000.120	-

INOX 304	
Cod.	P.V.P.
1900.176	27,56 €
1900.178	31,06 €
1900.180	33,40 €
1900.182	36,24 €
-	-
1900.183	49,03 €
1900.184	50,61 €
-	-
1900.186	60,89 €
-	-
1900.187	78,77 €
1900.188	94,73 €
1900.189	102,99 €



FIG. 22

HEMBRA ROSCA

ENLACE BASE	ROSCA	ACERO ZINCADO		INOX 304	
		Cod.	P.V.P.	Cod.	P.V.P.
50	1"	1000.655	12,22 €	1900.116	31,78 €
	1 1/4"	1000.656	10,85 €	1900.118	32,76 €
	1" 1/2	1000.657	11,20 €	1900.120	34,59 €
	2"	1000.850	12,63 €	1900.122	38,38 €
60	2"	1000.658	12,57 €	-	-
80	2 1/2"	1000.659	17,89 €	1900.124	50,90 €
	3"	1000.660	19,29 €	1900.126	55,09 €
100	3 1/2"	1000.661	22,14 €	-	-
	4"	-	-	1900.128	70,60 €
115	4"	1000.662	28,08 €	-	-
	4 1/2"	-	-	1900.130	89,24 €
140	5"	1000.663	41,11 €	1900.132	108,01 €
	6"	1000.664	43,03 €	1900.133	108,01 €



FIG. 22 R.I.

HEMBRA ROSCA INTERIOR

ENLACE BASE	ROSCA	ACERO ZINCADO	
		Cod.	P.V.P.
50	1"	1000.125	10,85 €
	1 1/4"	1000.126	11,03 €
	1" 1/2	1000.127	11,21 €
	2"	1000.851	13,66 €
60	2"	1000.128	13,43 €
80	2 1/2"	1000.129	17,43 €
	3"	1000.130	19,35 €
115	4"	1000.132	27,54 €
140	5"	1000.133	43,43 €
	6"	1000.134	-



FIG. 21

HEMBRA MANGUERA

ENLACE BASE	Ø MANGUERA	ACERO ZINCADO		INOX 304	
		Cod.	P.V.P.	Cod.	P.V.P.
50	30	1000.061	8,82 €	1900.085	31,46 €
	35	1000.062	-	1900.086	31,46 €
	40	1000.063	8,87 €	1900.088	32,44 €
	45	1000.064	8,48 €	1900.090	32,44 €
	50	1000.065	8,50 €	1900.092	34,24 €
	60	1000.840	9,78 €	1900.094	37,98 €
60	60	1000.066	9,90 €	-	-
80	70	1000.067	13,94 €	1900.096	49,89 €
	75	1000.068	13,37 €	1900.098	49,89 €
	80	1000.069	13,44 €	1900.100	53,66 €
	90	1000.070	14,84 €	1900.102	53,66 €
100	100	1000.071	16,06 €	1900.104	72,98 €
	110	-	-	1900.106	72,98 €
115	110	1000.072	19,93 €	-	-
	115	1000.073	19,95 €	-	-
	120	1000.079	20,46 €	1900.108	95,06 €
	125	1000.074	23,78 €	1900.110	95,06 €
140	140	1000.075	29,33 €	-	-
	150	1000.076	34,34 €	1900.114	112,21 €
200	200	1000.077	68,10 €	-	-
250	250	1000.078	-	-	-

PARA ENLACES ESPECIALES CONSULTENOS





FIG. 27

MACHO MANGUERA

ENLACE BASE	Ø MANGUERA
50	30
	35
	40
	45
	50
	60
60	60
80	70
	75
	80
	90
100	100
	110
115	110
	115
	120
	125
140	140
	150
200	200
250	250

ACERO ZINCADO	
Cod.	P.V.P.
1000.141	5,10 €
1000.142	-
1000.143	5,14 €
1000.144	4,75 €
1000.145	4,78 €
1000.844	6,58 €
1000.146	6,67 €
1000.147	10,57 €
1000.148	10,00 €
1000.149	10,07 €
1000.150	11,47 €
1000.151	13,90 €
-	-
1000.152	16,43 €
1000.153	16,45 €
1000.159	16,96 €
1000.154	19,59 €
1000.155	26,70 €
1000.156	31,71 €
1000.157	54,92 €
1000.158	-

INOX 304	
Cod.	P.V.P.
1900.190	24,51 €
1900.191	24,51 €
1900.192	27,53 €
1900.194	27,53 €
1900.196	29,59 €
1900.198	30,37 €
-	-
1900.200	42,62 €
1900.202	42,62 €
1900.204	43,98 €
1900.206	43,98 €
1900.208	70,88 €
1900.210	70,88 €
-	-
-	-
1900.212	85,18 €
1900.214	85,18 €
-	-
1900.218	106,41 €
-	-
-	-

ÚNETE A NUESTRO GRUPO BOMBAS VILPIN EN:

facebook

FIG. 41
TAPON HEMBRA

ENLACE BASE
50
60
80
100
115
140
200

ACERO ZINCADO	
Cod.	P.V.P.
1000.481	8,58 €
1000.482	10,00 €
1000.483	13,34 €
1000.484	16,81 €
1000.485	20,17 €
1000.486	25,29 €
1000.487	64,43 €

INOX 304	
Cod.	P.V.P.
1900.222	20,99 €
-	-
1900.224	38,83 €
1900.226	46,20 €
1900.228	51,48 €
1900.230	66,64 €
-	-

FIG. 42
TAPON MACHO

ENLACE BASE
50
60
80
100
115
140
200

ACERO ZINCADO	
Cod.	P.V.P.
1000.491	9,25 €
1000.492	11,14 €
1000.493	15,26 €
1000.494	20,12 €
1000.495	23,68 €
1000.496	29,56 €
1000.497	56,95 €

INOX 304	
Cod.	P.V.P.
1900.728	16,67 €
-	-
1900.736	33,08 €
1900.740	41,59 €
1900.744	50,83 €
1900.750	68,40 €
-	-



FIG. 17

HEMBRA MANGUERA CODO 90°

ENLACE BASE	Ø MANGUERA
50	30
	35
	40
	45
	50
	60
60	60
80	70
	75
	80
	90
100	100
	110
115	110
	115
	120
	125
140	140
	150
200	200
250	250

ACERO ZINCADO	
Cod.	P.V.P.
1000.041	12,37 €
1000.042	-
1000.043	12,18 €
1000.044	12,25 €
1000.045	12,28 €
1000.843	14,05 €
1000.046	15,45 €
1000.047	21,57 €
1000.048	21,61 €
1000.049	21,68 €
1000.050	26,09 €
1000.051	32,74 €
-	-
1000.052	38,99 €
1000.053	39,01 €
1000.059	50,39 €
1000.054	53,36 €
1000.055	88,61 €
1000.056	93,96 €
1000.057	189,32 €
1000.058	-

INOX 304	
Cod.	P.V.P.
1900.050	44,31 €
1900.051	44,31 €
1900.052	44,31 €
1900.054	44,31 €
1900.056	48,54 €
1900.058	55,19 €
-	-
1900.060	75,40 €
1900.062	75,40 €
1900.064	90,32 €
1900.066	90,32 €
1900.068	131,56 €
1900.070	131,56 €
-	-
-	-
1900.072	208,22 €
1900.074	208,22 €
-	-
1900.078	257,08 €
-	-
-	-

VEA NUESTROS CATÁLOGOS EN: www.vilpin.com





FIG. 24

HEMBRA ROSCA CODO 90°

ENLACE BASE	ROSCA
50	1"
	1 1/4"
	1" 1/2
	2"
60	2"
80	2 1/2"
	3"
100	3 1/2"
115	4"
140	5"
	6"

ACERO ZINCADO	
Cod.	P.V.P.
1000.670	15,99 €
1000.671	14,63 €
1000.672	14,98 €
1000.842	17,06 €
1000.673	18,12 €
1000.674	26,13 €
1000.675	30,20 €
1000.676	39,24 €
1000.677	50,23 €
1000.678	76,66 €
1000.679	103,69 €



FIG. 34

MACHO ROSCA CODO 90°

ENLACE BASE	ROSCA
50	1"
	1 1/4"
	1" 1/2
	2"
60	2"
80	2 1/2"
	3"
100	3 1/2"
115	4"
140	5"
	6"

ACERO ZINCADO	
Cod.	P.V.P.
1000.351	12,43 €
1000.352	11,07 €
1000.353	11,42 €
1000.846	13,02 €
1000.354	14,88 €
1000.355	22,76 €
1000.356	26,83 €
1000.357	36,57 €
1000.358	47,26 €
1000.359	73,34 €
1000.360	101,13 €



FIG. 26

MACHO MANGUERA CODO 90°

ENLACE BASE	Ø MANGUERA
50	30
	35
	40
	45
	50
	60
60	60
80	70
	75
	80
	90
100	100
	110
115	110
	115
	120
	125
140	140
	150
200	200

ACERO ZINCADO	
Cod.	P.V.P.
1000.331	8,81 €
1000.332	-
1000.333	8,63 €
1000.334	8,70 €
1000.335	8,72 €
1000.845	10,35 €
1000.336	12,22 €
1000.337	18,20 €
1000.338	18,24 €
1000.339	18,31 €
1000.340	22,72 €
1000.341	30,07 €
-	-
1000.342	36,01 €
1000.343	36,03 €
1000.349	47,41 €
1000.344	50,01 €
1000.345	85,28 €
1000.346	89,88 €
1000.347	176,14 €

INOX 304	
Cod.	P.V.P.
1900.331	39,36 €
1900.332	39,36 €
1900.333	39,36 €
1900.334	39,36 €
1900.335	43,87 €
1900.336	48,53 €
-	-
1900.337	68,12 €
1900.338	68,12 €
1900.339	80,97 €
1900.340	80,97 €
1900.341	122,42 €
1900.342	122,42 €
-	-
-	-
1900.343	214,31 €
1900.344	214,31 €
-	-
1900.346	259,57 €
-	-

VEA NUESTROS VIDEOS EN: www.vilpin.com





FIG. 43

MACHO - HEMBRA CODO 90°

ENLACE BASE
50
60
80
100
115
140
200

ACERO ZINCADO	
Cod.	P.V.P.
1000.505	14,11 €
1000.506	18,44 €
1000.509	26,35 €
1000.511	38,14 €
1000.513	47,31 €
1000.515	72,62 €
1000.517	205,06 €

INOX 304	
Cod.	P.V.P.
1900.240	56,73 €
-	-
1900.248	107,93 €
1900.252	148,96 €
1900.256	230,20 €
1900.260	269,62 €
-	-



FIG. 39

MANGUERA - MANGUERA CODO 90°

Ø MANGUERA
30
40
45
50
60
70
75
80
90
100
110
115
120
125
140
150
200

ACERO ZINCADO	
Cod.	P.V.P.
1000.231	7,24 €
1000.233	6,88 €
1000.234	7,02 €
1000.235	7,06 €
1000.236	9,75 €
1000.237	14,97 €
1000.238	15,06 €
1000.239	15,20 €
1000.240	19,30 €
1000.241	26,05 €
1000.242	30,63 €
1000.243	30,68 €
1000.249	42,56 €
1000.244	45,12 €
1000.245	79,17 €
1000.246	84,96 €
1000.247	160,40 €

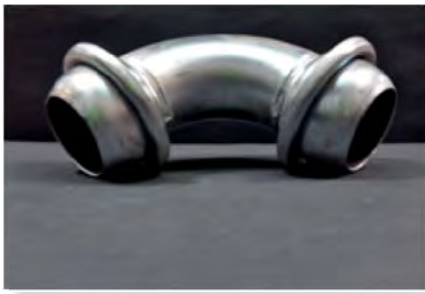

FIG. 36

MACHO - MACHO CODO 90°

ENLACE BASE
50
60
80
100
115
140
200

ACERO ZINCADO	
Cod.	P.V.P.
1000.385	10,73 €
1000.386	15,29 €
1000.389	22,81 €
1000.391	34,77 €
1000.393	41,39 €
1000.395	68,26 €
1000.397	191,88 €



FIG. 50

BRIDA PN-10 SOLDAR

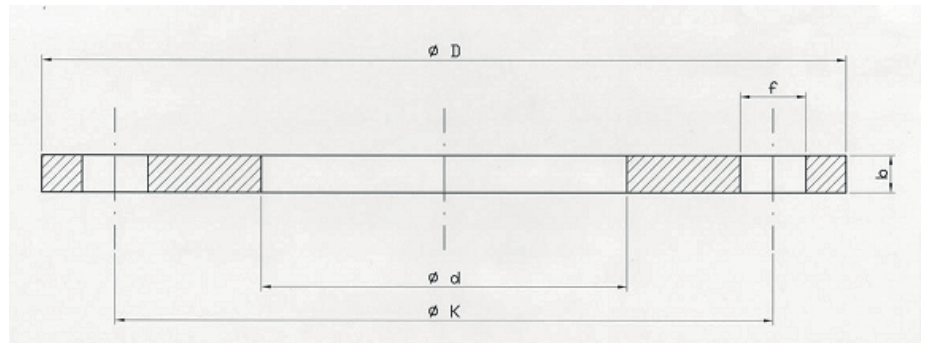

BRIDA DN
DN-40
DN-50
DN-65
DN-80
DN-100
DN-125
DN-150
DN-200
DN-250

ACERO ZINCADO	
Cod.	P.V.P.
1800.071	6,81 €
1800.072	8,03 €
1800.074	9,91 €
1800.075	10,75 €
1800.076	11,94 €
1800.077	17,00 €
1800.078	23,28 €
1800.079	41,96 €
1800.080	66,69 €

MEDIDA					
Ø D	Ø K	d	f	b	Nº tal.
150	110	48,5	18	8	4
165	125	61	18	8	4
185	145	76	18	8	4
200	160	88	18	9	4
220	180	100	18	10	4
250	210	125	18	10	4
285	240	151	22	12	8
340	295	201	22	14	8
395	350	273	22	15	12



FIG. 45

MACHO BRIDA PN-10

BRIDA DN	ENLACE BASE
DN-40	50
	60
DN-50	50
	60
DN-65	60
	80
DN-80	80
	100
DN-100	100
	115
DN-125	115
	140
DN-150	140
	200
DN-200	200
DN-250	250

ACERO ZINCADO	
Cod.	P.V.P.
1000.700	15,38 €
1000.705	16,96 €
1000.715	17,84 €
1000.720	18,83 €
1000.727	22,13 €
1000.728	25,67 €
1000.730	28,07 €
1000.735	32,72 €
1000.750	33,85 €
1000.755	38,94 €
1000.765	43,72 €
1000.770	53,70 €
1000.780	62,10 €
1000.785	84,00 €
1000.795	117,46 €
1000.800	-

VEA NUESTROS CATÁLOGOS EN: www.vilpin.com





FIG. 40

BRIDA MANGUERA

BRIDA DN	Ø MANGUERA	ACERO ZINCADO	
		Cod.	P.V.P.
DN-40	40	1000.920	12,58 €
	45	1000.922	12,35 €
	50	1000.924	13,22 €
DN-50	50	1000.930	14,75 €
	60	1000.932	14,52 €
DN-65	70	1000.936	18,43 €
	75	1000.938	18,06 €
	80	1000.940	19,67 €
DN-80	80	1000.944	21,06 €
	90	1000.946	22,46 €
DN-100	90	1000.952	23,39 €
	100	1000.954	23,52 €
DN-125	125	1000.962	33,93 €
	150	1000.964	39,54 €
DN-150	150	1000.968	47,91 €
	200	1000.970	-
DN-200	150	1000.972	-
	200	1000.974	95,39 €
DN-250	250	1000.976	-

ÚNETE A NUESTRO GRUPO BOMBAS VILPIN EN:

facebook

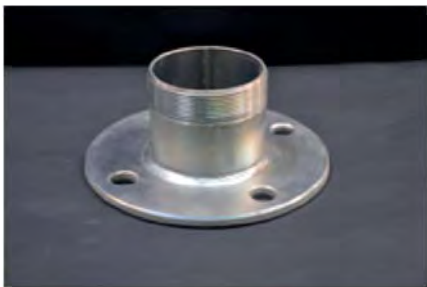

FIG. 10

BRIDA ROSCA EXTERIOR

BRIDA DN	ROSCA
DN-40	1 1/2"
	2"
DN-50	1 1/2"
	2"
DN-65	2 1/2"
	3"
DN-80	3"
	3 1/2"
DN-100	4"
DN-125	4"
	5"
DN-150	5"
	6"

ACERO ZINCADO	
Cod.	P.V.P.
1001.120	15,08 €
1001.121	15,72 €
1001.125	17,45 €
1001.126	17,19 €
1001.130	21,89 €
1001.131	23,46 €
1001.134	25,80 €
1001.135	28,52 €
1001.138	32,84 €
1001.140	40,08 €
1001.142	47,70 €
1001.145	55,79 €
1001.148	57,33 €



FIG. 12

BRIDA ROSCA INTERIOR

BRIDA DN	ROSCA
DN-40	1 1/2"
	2"
DN-50	1 1/2"
	2"
DN-65	2 1/2"
	3"
DN-80	2 1/2"
	3"
DN-100	4"
DN-125	4"
	5"
DN-150	5"

ACERO ZINCADO	
Cod.	P.V.P.
1001.160	15,08 €
1001.161	16,58 €
1001.165	17,45 €
1001.166	18,05 €
1001.170	21,43 €
1001.171	23,51 €
1001.174	25,09 €
1001.175	25,86 €
1001.178	32,30 €
1001.180	39,68 €
1001.182	51,68 €
1001.185	59,63 €



FIG. 28

BRIDA MANGUERA CODO 90°

BRIDA DN	Ø MANGUERA
DN-40	40
	45
	50
DN-50	50
	60
DN-65	50
	60
	75
DN-80	80
	90
DN-100	90
	100
DN-125	125
	150
DN-150	150
	200
DN-200	150
	200
DN-250	250

ACERO ZINCADO	
Cod.	P.V.P.
1000.270	15,97 €
1000.271	16,13 €
1000.272	16,23 €
1000.275	19,03 €
1000.276	20,07 €
1000.277	24,17 €
1000.278	24,62 €
1000.279	27,67 €
1000.282	31,62 €
1000.283	33,33 €
1000.286	39,16 €
1000.287	41,50 €
1000.291	65,42 €
1000.292	101,76 €
1000.294	110,12 €
1000.295	-
1000.296	-
1000.297	173,56 €
1000.298	-

VEA NUESTROS CATÁLOGOS EN: www.vilpin.com





FIG. 44

BRIDA MACHO CODO 90°

BRIDA DN	ENLACE BASE	ACERO ZINCADO	
		Cod.	P.V.P.
DN-40	50	1000.801	18,07 €
	60	1000.802	21,70 €
DN-50	50	1000.804	20,18 €
	60	1000.805	23,05 €
DN-65	60	1000.807	26,18 €
	80	1000.808	32,07 €
DN-80	80	1000.810	34,46 €
	100	1000.811	48,58 €
DN-100	100	1000.814	49,58 €
	115	1000.815	67,41 €
DN-125	115	1000.817	72,62 €
	140	1000.818	110,00 €
DN-150	140	1000.820	117,50 €
DN-200	200	1000.823	207,94 €



FIG. 14

JUNTA BRIDA PN-10 / PN-16

BRIDA DN	ACERO ZINCADO	
	Cod.	P.V.P.
DN-40	1800.051	1,07 €
DN-50	1800.052	1,13 €
DN-65	1800.054	1,32 €
DN-80	1800.055	1,55 €
DN-100	1800.057	1,84 €
DN-125	1800.058	2,07 €
DN-150	1800.059	2,42 €
DN-200	1800.060	4,87 €
DN-250	1800.061	5,55 €
DN-300	1800.062	8,70 €

ENTRONQUES, CODOS, ESPARCIDORES, ETC...



FIG. 29

TUBO ROSCADO (Sin zincar para soldar)

ROSA
1"
1 1/4"
1 1/2"
2"
2 1/2"
3"
3 1/2"
4"
5"
6"

LARGO mm	ACERO ZINCADO	
	Cod.	P.V.P.
45	1000.442	2,04 €
45	1000.443	2,11 €
45	1000.444	2,20 €
55	1000.445	2,88 €
60	1000.446	3,99 €
75	1000.447	5,21 €
85	1000.448	6,44 €
90	1000.449	7,86 €
100	1000.450	9,68 €
100	1000.451	11,37 €

LARGO mm	INOX 304	
	Cod.	P.V.P.
60	1900.370	4,47 €
60	1900.372	5,77 €
60	1900.374	6,06 €
60	1900.376	6,68 €
60	1900.378	11,26 €
60	1900.380	12,90 €
-	-	-
60	1900.384	16,33 €
60	1900.388	32,15 €
60	1900.390	51,88 €

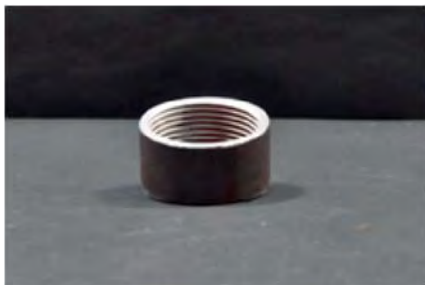

FIG. 20 R.I.

TUBO ROSCADO INTERIOR
(Sin zincar para soldar)

ROSCA
1"
1 1/4"
1 1/2"
2"
2 1/2"
3"
4"
5"
6"

ACERO ZINCADO	
Cod.	P.V.P.
1000.642	3,06 €
1000.643	3,24 €
1000.644	3,42 €
1000.645	4,45 €
1000.646	5,75 €
1000.647	6,72 €
1000.649	10,74 €
1000.650	20,49 €
1000.651	-



FIG. 38

TUBO MANGUERA CON BORDON
(Sin zincar para soldar)

Ø MANGUERA
30
40
50
60
70
75
80
90
100
110
115
120
125
150
200

LARGO mm	ACERO ZINCADO	
	Cod.	P.V.P.
60	1000.421	0,57 €
60	1000.423	0,63 €
60	1000.425	0,71 €
70	1000.426	0,92 €
90	1000.427	1,63 €
90	1000.428	1,69 €
90	1000.429	1,76 €
110	1000.430	2,22 €
110	1000.431	2,46 €
120	1000.432	2,98 €
120	1000.433	2,99 €
120	1000.439	3,50 €
130	1000.434	4,62 €
150	1000.436	8,36 €
200	1000.437	11,05 €

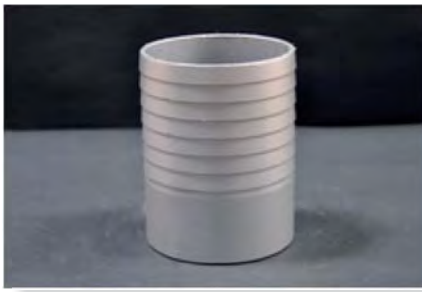

FIG. 16

**TUBO MANGUERA CON REGATAS
(Sin zincar para soldar)**

Ø MANGUERA
30
35
40
45
50
60
70
75
80
90
100
110
120
125
140
150
200
250

LARGO mm	ACERO ZINCADO	
	Cod.	P.V.P.
70	1000.181	2,24 €
-	-	-
70	1000.183	2,28 €
-	-	-
70	1000.185	2,55 €
75	1000.186	2,66 €
90	1000.187	3,46 €
115	1000.188	3,66 €
115	1000.189	3,85 €
120	1000.190	4,24 €
135	1000.191	4,80 €
130	1000.192	6,47 €
130	1000.193	6,75 €
130	1000.194	6,75 €
135	1000.195	10,43 €
140	1000.196	10,43 €
200	1000.197	21,89 €
250	1000.198	33,62 €

LARGO mm	INOX 304	
	Cod.	P.V.P.
70	1900.606	3,13 €
70	1900.608	3,31 €
70	1900.610	3,48 €
70	1900.612	4,22 €
70	1900.614	4,50 €
75	1900.616	5,17 €
90	1900.618	6,08 €
100	1900.620	8,59 €
100	1900.622	13,48 €
110	1900.624	15,66 €
110	1900.626	18,69 €
120	1900.628	20,27 €
130	1900.630	26,41 €
130	1900.632	27,19 €
135	1900.634	34,81 €
140	1900.636	40,53 €
200	1900.637	55,28 €
-	-	-

VEA NUESTROS CATÁLOGOS EN: www.vilpin.com

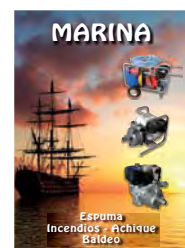



FIG. 47

ROSCA - MANGUERA

ROSCA
1"
1 1/4"
1 1/2"
2"
2 1/2"
3"
3 1/2"
4"
5"
6"

LARGO mm	ACERO ZINCADO	
	Cod.	P.V.P.
90	1000.541	3,75 €
100	1000.542	4,05 €
100	1000.543	4,34 €
100	1000.544	5,36 €
120	1000.545	6,56 €
140	1000.546	8,17 €
140	1000.547	10,10 €
150	1000.548	12,64 €
150	1000.549	17,28 €
200	1000.550	25,62 €

LARGO mm	INOX 304	
	Cod.	P.V.P.
90	1900.296	10,40 €
90	1900.298	13,56 €
90	1900.302	14,94 €
90	1900.304	17,95 €
110	1900.308	26,37 €
170	1900.312	48,72 €
-	-	-
180	1900.314	-
195	1900.316	-
-	-	-

Fabricamos también en medida 1/2" y 3/4"



FIG. 49

ROSCA - ROSCA

ROSCA
1"
1 1/4"
1 1/2"
2"
2 1/2"
3"
3 1/2"
4"
5"
6"

LARGO mm	ACERO ZINCADO	
	Cod.	P.V.P.
90	1000.581	3,75 €
100	1000.582	4,05 €
100	1000.583	4,34 €
100	1000.584	5,36 €
120	1000.585	6,56 €
140	1000.586	8,17 €
140	1000.587	10,10 €
150	1000.588	12,64 €
150	1000.589	17,28 €
200	1000.590	25,98 €

LARGO mm	INOX 304	
	Cod.	P.V.P.
70	1900.581	7,41 €
70	1900.582	7,90 €
70	1900.583	8,30 €
70	1900.584	10,57 €
80	1900.585	18,63 €
80	1900.586	17,06 €
-	-	-
100	1900.588	26,86 €
100	1900.589	61,68 €
100	1900.590	66,10 €

Fabricamos también en medida 1/2" y 3/4"

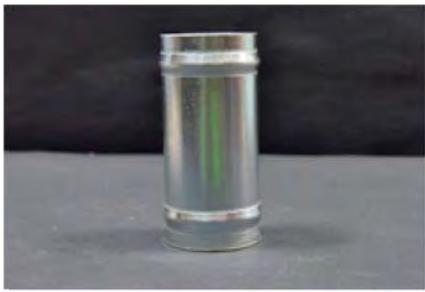

FIG. 48

MANGUERA - MANGUERA CON BORDON

Ø MANGUERA	LARGO mm	ACERO ZINCADO	
		Cod.	P.V.P.
30	70	1000.561	1,13 €
40	100	1000.563	1,44 €
50	100	1000.565	1,66 €
60	110	1000.566	2,09 €
70	180	1000.567	4,35 €
75	180	1000.568	4,58 €
80	180	1000.569	4,77 €
90	190	1000.570	5,56 €
100	190	1000.571	6,16 €
110	200	1000.572	7,24 €
115	200	1000.573	7,26 €
120	200	1000.560	8,35 €
125	220	1000.574	8,93 €
140	250	1000.575	15,56 €
150	250	1000.576	19,30 €
200	350	1000.577	28,90 €
250	-	1000.578	-

ÚNETE A NUESTRO GRUPO BOMBAS VILPIN EN:

facebook



FIG. 18

MANGUERA - MANGUERA CON REGATAS

Ø MANGUERA
30
35
40
45
50
60
70
75
80
90
100
110
120
125
140
150
200
250

LARGO mm	ACERO ZINCADO	
	Cod.	P.V.P.
120	1000.251	3,36 €
-	-	-
120	1000.253	3,72 €
-	-	-
120	1000.255	4,06 €
120	1000.256	4,36 €
140	1000.257	5,42 €
140	1000.258	6,47 €
180	1000.259	6,90 €
180	1000.260	7,74 €
200	1000.261	8,49 €
200	1000.262	12,34 €
230	1000.263	18,39 €
240	1000.264	18,39 €
250	1000.265	21,69 €
250	1000.266	21,69 €
400	1000.267	46,61 €
500	1000.268	79,72 €

LARGO mm	INOX 304	
	Cod.	P.V.P.
120	1900.780	4,97 €
120	1900.782	4,97 €
120	1900.784	6,74 €
120	1900.786	6,74 €
120	1900.788	8,21 €
120	1900.790	8,67 €
140	1900.792	11,95 €
180	1900.794	14,22 €
200	1900.796	34,45 €
220	1900.798	39,13 €
220	1900.800	45,40 €
240	1900.802	50,02 €
260	1900.806	61,85 €
260	1900.807	61,85 €
270	1900.808	71,94 €
280	1900.810	81,00 €
400	1900.811	127,84 €
-	-	-



FIG. 19

REDUCCIÓN MANGUERA - MANGUERA

Ø MANGUERA	30 - 40 - 45 - 50 - 60 - 70 - 75 - 80 - 90 - 100 - 110 - 125 - 140 - 150 - 200 - 250
Consultar precio.	

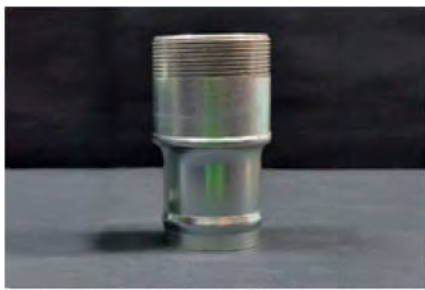

FIG. 32

REDUCCIÓN ROSCA - MANGUERA

ROSCA	Ø MANGUERA	ACERO ZINCADO		INOX 304	
		Cod.	P.V.P.	Cod.	P.V.P.
1 1/2"	40	1000.601	6,14 €	1900.475	18,30 €
	50	1000.602	5,47 €	-	-
2"	50	1000.606	7,43 €	1900.479	23,58 €
	70	1000.607	8,00 €	-	-
	75	1000.608	8,43 €	-	-
2 1/2"	60	1000.614	10,37 €	-	-
	70	1000.615	10,86 €	1900.482	35,28 €
	80	1000.616	11,15 €	1900.484	35,28 €
	90	1000.617	11,92 €	1900.483	35,28 €
3"	70	1000.621	11,66 €	-	-
	75	1000.622	11,47 €	1900.485	46,41 €
	80	1000.623	11,39 €	1900.486	46,41 €
4"	100	1000.628	19,36 €	1900.494	53,31 €
	110	1000.629	19,10 €	-	-
	125	1000.632	21,12 €	1900.495	56,77 €
5"	140	1000.633	-	-	-
	150	1000.634	31,28 €	1900.498	83,55 €
6"	140	1000.635	-	-	-
	150	1000.636	32,44 €	1900.500	103,77 €



FIG. 70

REDUCCIÓN ROSCA - ROSCA

ROSCA	3/4" - 1" - 1 1/4" - 1 1/2" - 2" - 2 1/2" - 3" - 3 1/2" - 4" - 5" - 6"
Consultar precio.	



FIG. 30

**CONO CONCÉNTRICO
(Sin zincar para soldar)**

Ø EXTERIOR
50 / 100
50 / 120
60 / 80
60 / 100
60 / 150
80 / 120
100 / 150
120 / 150
150 / 200

ACERO ZINCADO	
Cod.	P.V.P.
1000.166	7,13 €
1000.167	7,70 €
1000.164	3,53 €
1000.161	3,53 €
1000.165	9,49 €
1000.169	5,40 €
1000.162	5,40 €
1000.163	5,40 €
1000.168	8,17 €

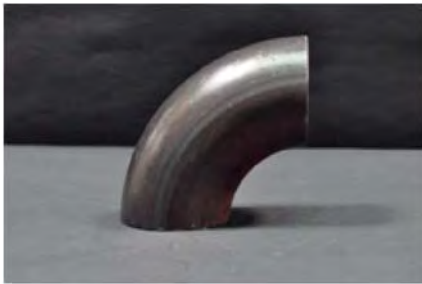

FIG. 46

**CURVA 90° Norma 3
(Sin zincar para soldar)**

Ø EXTERIOR
34
43
48
60
76
89
100
114
133
140
159
200

MEDIDA	ACERO ZINCADO	
	Cod.	P.V.P.
1"	1001.103	1,69 €
1 1/4"	1001.104	1,99 €
1 1/2"	1001.105	2,49 €
2"	1001.106	3,77 €
2 1/2"	1001.107	5,54 €
3"	1001.108	8,03 €
3 1/2"	1001.109	12,54 €
4"	1001.110	13,90 €
	1001.112	23,04 €
5"	1001.113	25,20 €
	1001.114	48,68 €
8"	1001.116	97,27 €



FIG. 90

ESPARCIDOR HEMBRA

ENLACE BASE
100
115
140
200

ACERO ZINCADO	
Cod.	P.V.P.
1001.192	55,20 €
1001.193	61,24 €
1001.194	69,52 €
1001.195	178,50 €



FIG. 93

ESPARCIDOR MACHO

ENLACE BASE
100
115
140

ACERO ZINCADO	
Cod.	P.V.P.
1001.197	51,50 €
1001.198	57,78 €
1001.199	71,17 €



FIG. 91

ESPARCIDOR CODO HEMBRA

ENLACE BASE
100
115
140

ACERO ZINCADO	
Cod.	P.V.P.
1001.205	65,72 €
1001.206	84,36 €
1001.207	108,97 €



FIG. 92

ESPARCIDOR CODO MACHO

ENLACE BASE
100
115
140

ACERO ZINCADO	
Cod.	P.V.P.
1001.215	53,28 €
1001.216	68,13 €
1001.217	97,38 €